

HMCG22B481S - RES SPLT AC 16SEER2 4.0T R410A HD MOD

REPAIR PARTS LIST

PRINTED DATE: 4/8/2024 for Model Number: HMCG22B481S, Produced: 2/15/2024

The information provided to you may include Johnson Controls' trade secrets, intellectual property, and confidential business information (including its Bill of Materials), and this information is to be kept in the strictest confidence and not to be disclosed to any third party without the prior written consent of Johnson Controls.

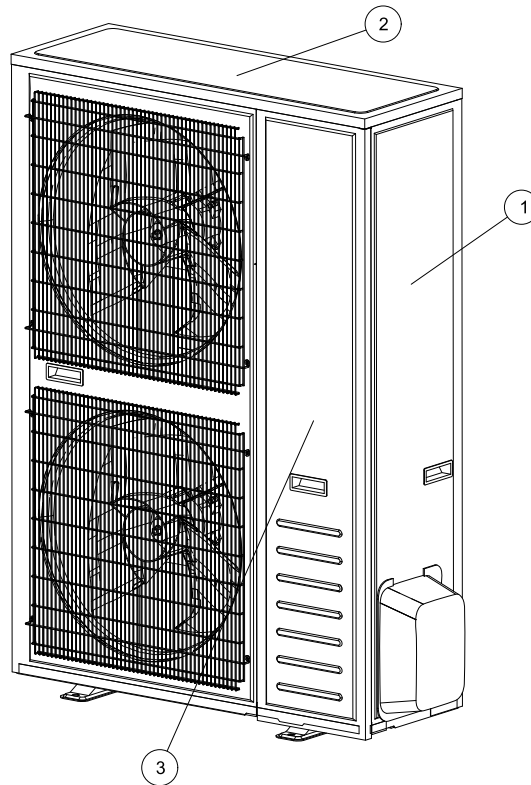

Section	Description
1	ELECTRICAL BOX / CONTROLS
2	SHEET METAL / CABINET PARTS
3	REFRIGERATION SYSTEM
8	MISCELLANEOUS

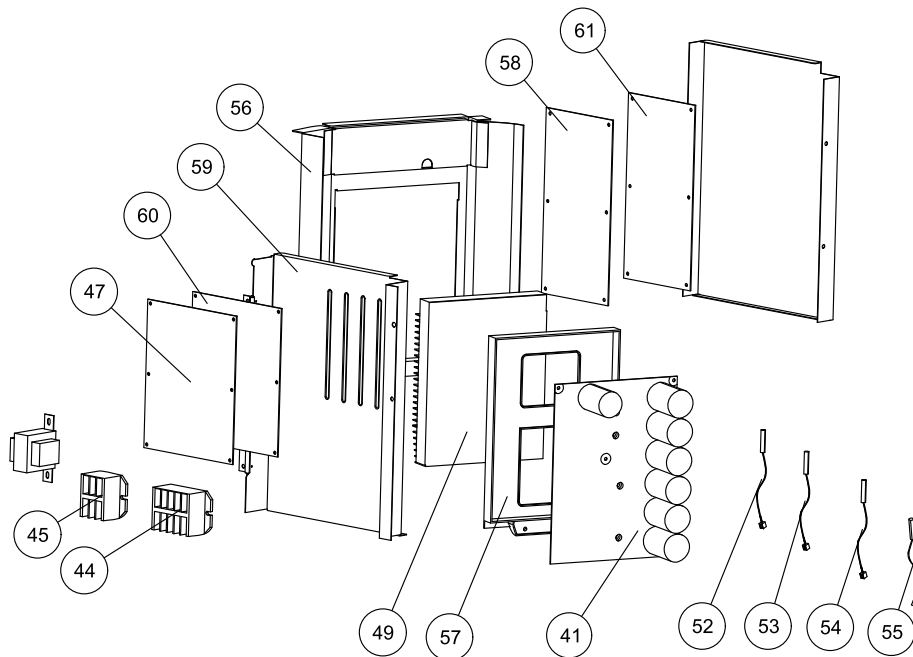
Section : ELECTRICAL BOX / CONTROLS

Section	Callout	Replacement Part #	Description	Original Part #	HMCG22B481S
1	5	S1-1971180	BOLT,COND MOTOR	S1-1971180	8
1	41	S1-2248049	BOARD,CONTROL,INVERTER,48K/60K	S1-2248049	1
1	44	S1-2150410	TERMINAL BLOCK,5 POLE,20A,300V,18AWG	S1-2150410	1
1	45	S1-1993161	TERMINAL BLOCK,3 POLE,30A,600V,9AWG	S1-1993161	1
1	47	S1-2247539	BOARD,CONTROL/DISPLAY	S1-2247539	1
1	49	S1-2243739	HEAT SINK,INVERTER	S1-2243739	1
1	50	S1-1440764	INSULATION,SPACER,HEAT SINK	S1-1440764	3
1	53	S1-1395042	SENSOR,TEMP,DISCH,-22/221 F,47.2 IN LEAD	S1-1395042	1
1	54	S1-1902722	SENSOR,TEMP,AMB,-22/221 F,33.5 IN LEAD	S1-1902722	1
1	55	S1-1823040	SENSOR,TEMP,DISCH,-22/221 F,47.2 IN LEAD	S1-1823040	1
1	56	S1-1464281	CASING,INVERTER CONTROL BOARD	S1-1464281	1
1	57	S1-1519508	MOUNT,HEAT SINK TO INVERTER	S1-1519508	1
1	58	S1-1421352	INSULATION,FILM,PLASTIC	S1-1421352	1
1	59	S1-1464292	PNL,CONTROL	S1-1464292	1
1	60	S1-2096599	INSULATION,FILM,PLASTIC	S1-2096599	1
1	61	S1-2095101	FILTER BOARD	S1-2095101	1

Suggested stocking items are shown with shaded item number.

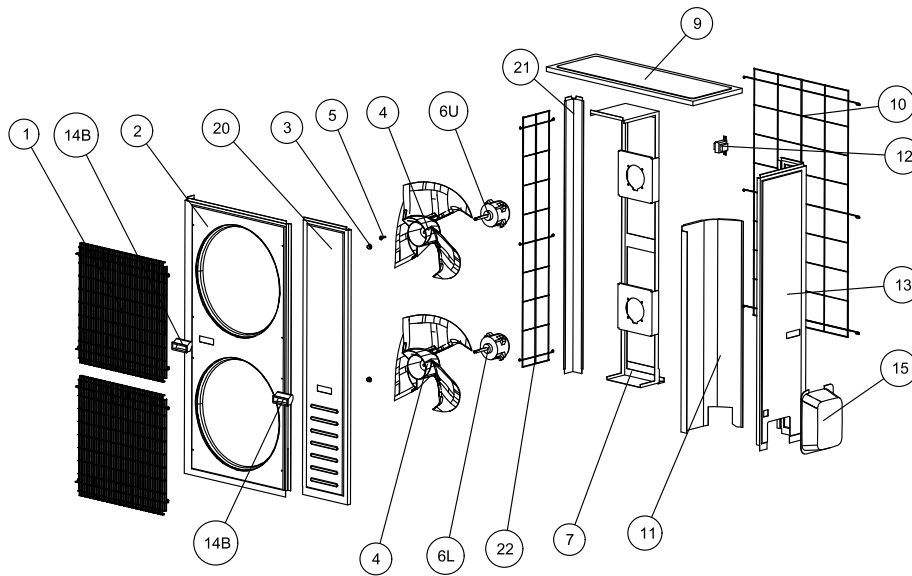
Section : SHEET METAL / CABINET PARTS

Section	Callout	Replacement Part #	Description	Original Part #	HMCG22B481S
2	1	S1-2118361	GUARD,FAN	S1-2118361	2
2	2	S1-1424731	PNL,VENTURI	S1-1424731	1
2	4	S1-1899961	PROP,FAN,19.8 IN,3 BLADE,120 BLADE ANGLE	S1-1899961	2
2	6L	S1-1464268	MTR,COND,LOWER,1/6,850/1,230-1-60	S1-1464268	1
2	6U	S1-1421124	MTR,COND,1/6,810/1,230-1-60	S1-1421124	1
2	7	S1-1889227	BRACKET,COND MOTOR SUPPORT	S1-1889227	1
2	9	S1-1942918	PNL,TOP	S1-1942918	1
2	10	S1-1470773	GUARD,COIL,BACK	S1-1470773	1
2	11	S1-1460536	BARRIER,COMPRESSOR	S1-1460536	1
2	12	S1-1400760	REACTOR,1PH,40A,3.0MH	S1-1400760	1
2	13	S1-2114432	PNL,ACCESS,SIDE	S1-2114432	1
2	14B	S1-1202703	HANDLE,PANEL,VENTURI	S1-1202703	2
2	15	S1-1472878	COVER,BASE VALVE	S1-1472878	1
2	16	S1-1546721	PLATE,SENSOR MOUNTING	S1-1546721	1
2	20	S1-1424733	PNL,ACCESS,FRONT	S1-1424733	1
2	21	S1-1424843	POST,CORNER	S1-1424843	1
2	22	S1-1470782	GUARD,COIL,LEFT	S1-1470782	1

Suggested stocking items are shown with shaded item number.

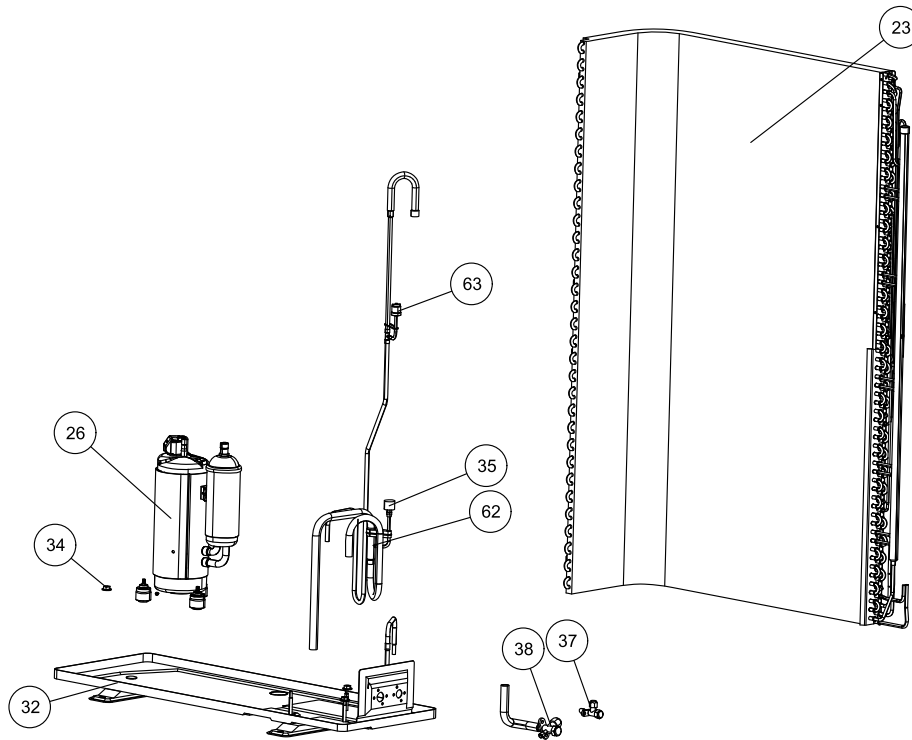
Section : REFRIGERATION SYSTEM

Section	Callout	Replacement Part #	Description	Original Part #	HMCG22B481S
3	23	S1-2247664	COIL,OD FORMED ASSEM	S1-2247664	1
3	26	S1-2159273	COMPR,TWIN ROTARY,230V,1PH,R-410A,VG74	S1-2159273	1
3	35	S1-1464759	TRANSDUCER,PRES,REFRIG	S1-1464759	1
3	37	S1-1466345	VLV,BASE,LIQUID	S1-1466345	1
3	37	S1-2031010	VLV,BASE,LIQUID	S1-2031010	1
3	38	S1-2108768	VLV,BASE,SUCTION	S1-2108768	1
3	38	S1-2110442	VLV,BASE,SUCTION	S1-2110442	1
3	62	S1-1918068	CNTRL,PRES,REFRIG,HIGH PRESSURE	S1-1918068	1

Suggested stocking items are shown with shaded item number.

Section : MISCELLANEOUS

Section	Callout	Replacement Part #	Description	Original Part #	HMCG22B481S
8	NS	S1-1938338	HARNESS,COMPRESSOR	S1-1938338	1

Suggested stocking items are shown with shaded item number.

Model series repair parts lists are generated for each model number from the last production bill of material.

Major components and suggested stocking items are shown with shaded item number.

Repair parts lists are subject to change without notice.

TO ORDER AUTHORIZED FACTORY REPLACEMENT PARTS - Contact your Source1 HVAC Parts Distributor or visit our website at www.Source1Parts.com for a Distributor and Dealer listing.

Copyright © 2024 by Johnson Controls Inc. All rights reserved.

Johnson Controls Unitary Products